



Schindler 6000

Unique, stylish and efficient



With a Schindler 6000,

the sky's
the limit



With the latest technologies, premium finishes, larger capacities and flexibility for custom design options – **Schindler 6000 delivers a first-class passenger experience.** Our Swiss-engineered materials and components have been developed to deliver superior performance and energy efficiency. **The Schindler 6000 supports a greener future.**



Schindler 6000

Unique, stylish and efficient

The Schindler 6000 offers a variety of design and dimensional combinations from a single product line, and can be tailored to suit any urban environment. Select from a full spectrum of styles, colours and options to find the best possible solution for your building.

The Schindler 6000 is part of the new modular platform product range. From basic to sophisticated requirements, the Schindler 6000 is suitable for low- to high-rise applications in offices, residential apartments, hotels and educational buildings.

Key figures

Capacity	630 - 2600 kg
Travel height	Up to 150 m
Stops	Up to 50 stops
Speed	1.0m/s 1.5m/s 1.75m/s 2.0m/s 2.5m/s 3.0m/s
Drive system	Machine-room-less, eco-friendly regenerative drive technology, frequency controlled
Group size	Up to 8 cars
Entrances	Single or Through entry car
Interior	4 interior design lines, fresh wall colours or a bare car option for your own local custom interior design

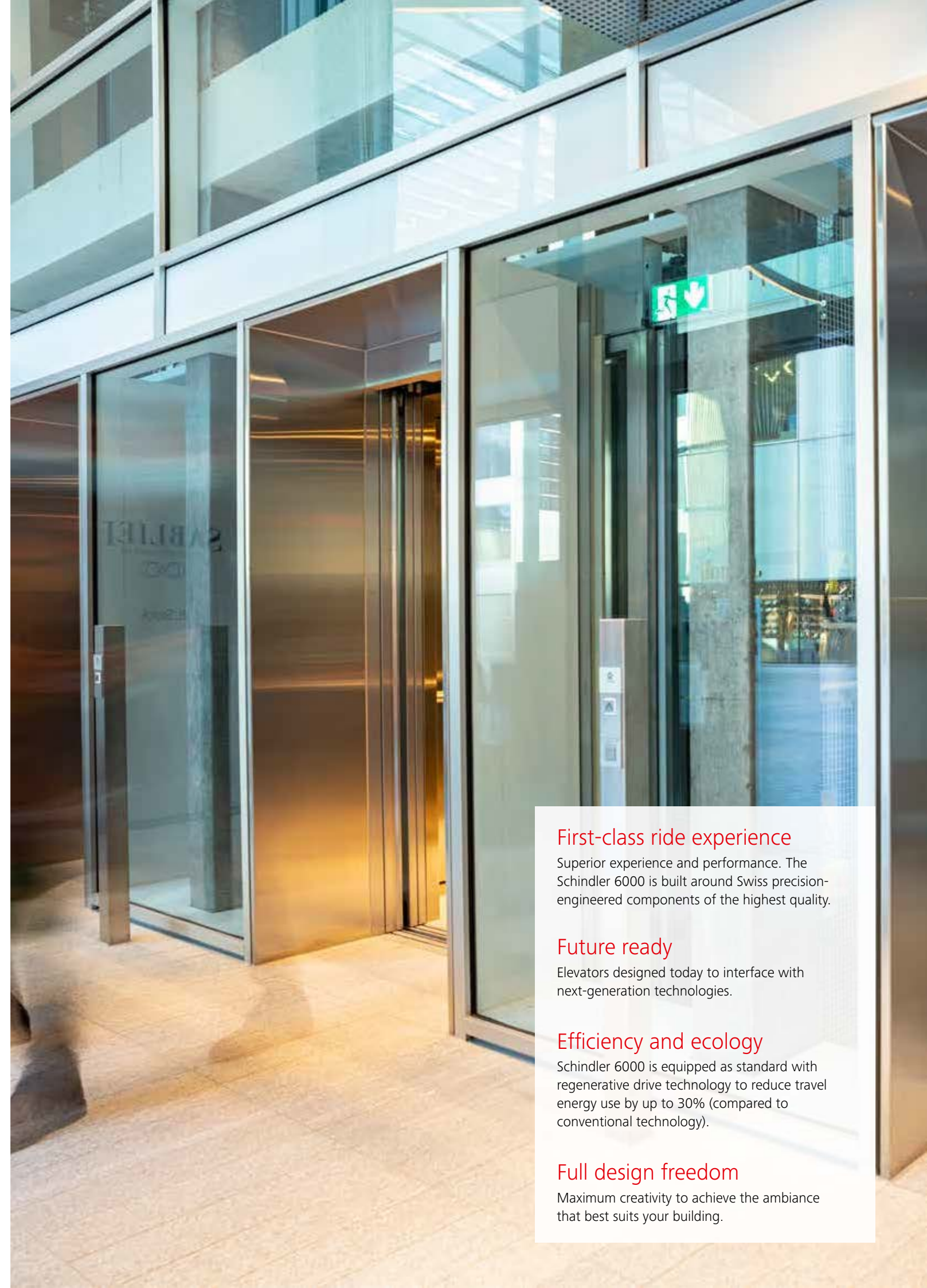

First-class ride experience

Superior experience and performance. The Schindler 6000 is built around Swiss precision-engineered components of the highest quality.

Future ready

Elevators designed today to interface with next-generation technologies.

Efficiency and ecology

Schindler 6000 is equipped as standard with regenerative drive technology to reduce travel energy use by up to 30% (compared to conventional technology).

Full design freedom

Maximum creativity to achieve the ambience that best suits your building.

Designed for comfort – built to last

Engineered to Swiss standards

Schindler 6000 is designed, engineered and rigorously tested to ensure smooth, quiet and economical operation throughout your elevator's long life cycle, for every application, and in any environment.



Latest technologies, greater comfort

Variable frequency drive systems deliver perfectly controlled power to traction machines and door drives, extending component lifetimes and increasing energy efficiency. Schindler Suspension Traction Media is light and long-lasting, enabling the use of smaller traction machines that reduce both energy consumption and noise and vibration levels in the car.

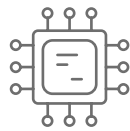

State-of-the-art digital controller

Schindler's scalable (universal) elevator controller offers more flexibility in number of openings, number of stops, and car group size. What's more, Schindler's innovative EPIC sensor data transfer system for the controller improves both reliability and maintainability for all Schindler controllers.



High-quality – at every level

Contact-free sensors assure millimeter-precise leveling with the floor for safe, seamless movement of passengers and goods in and out of the elevator.



Innovative drive technology

Schindler 6000 is equipped as standard with our innovative, regenerative drive technology. The system is designed to reduce travel energy by up to 30% compared to any conventional technology available.



Excellent ecological performance

Improving energy efficiency is essential to reduce the environmental impact of elevators and the buildings they serve. Eco-friendly features, such as regenerative drive, LED lighting and stand-by mode while parked, are standard in all Schindler 6000 elevators, achieving the highest energy-efficiency rating class A according to ISO 25745-2.



Elevator segments

Tailored to Schindler 6000

We Elevate...

Offices

Our elevators and escalators deliver passengers to their offices safely, quietly, efficiently and in comfort. Offering flexibility in design, car sizes and control options, our elevators and escalators run at maximum efficiency during peak traffic and reduce energy consumption off-peak.

We Elevate...

Residential

Developers and owners of residential properties can always count on Schindler for stylish in-building transport that is safe, durable, smooth to ride, and highly efficient. With lighting, fixtures and colours to match the building's architecture, we assure premium mobility for owners, facility managers and residents alike.

We Elevate...

Hotels

With many years of experience supplying elevators and escalators to hotels worldwide, we deliver guests to their rooms quietly, efficiently and comfortably. Using the latest technology, we bring a new aesthetic design, enhanced security, in-car entertainment and exceptional performance that's matched to guests' needs and hotel requirements.

We Elevate...

Healthcare

Specifically designed for healthcare, retirement and spa facilities, our bed elevator is reliable, durable and attractive. It's also spacious enough to hold both patients and equipment at the same time. We offer special control options for emergency services and cleaning staff.

Architectural flexibility

Less space, more capacity

The Schindler 6000 benefits from our machine room-less (MRL) traction systems and compact door drives to optimise shaft space, reducing construction costs and leaving space for tenants.

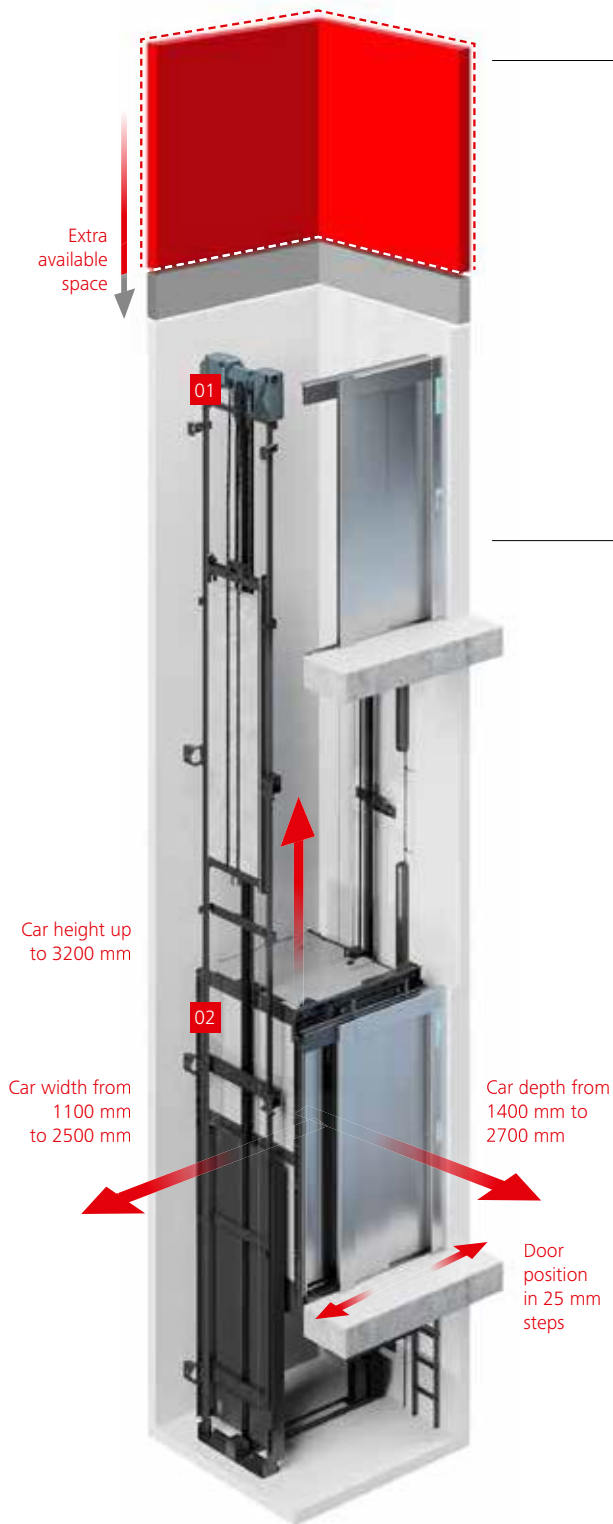

Machine-room-less design

All main drive, traction and control equipment sits in the shaft, leaving architects and designers free to use the extra space for more productive purposes. The Schindler 6000 allows a larger car to be fitted into a standard shaft space.

Modular system and door dimensions

The Schindler 6000 car width is available from 1100 mm to 2500 mm, car depth from 1400 mm to 2700 mm, and car height up to 3200 mm.

Doors can be sized and positioned with millimeter accuracy. Door width from 900 mm to 1800 mm.

Door heights from 2000 mm to 3000 mm, with a choice of Telescopic (T2), two panel Centre-opening doors (C2) or four panel Centre-opening doors (C4).

Both width and height are adjustable in 100mm increments.

All are available in Single or Through entry car.

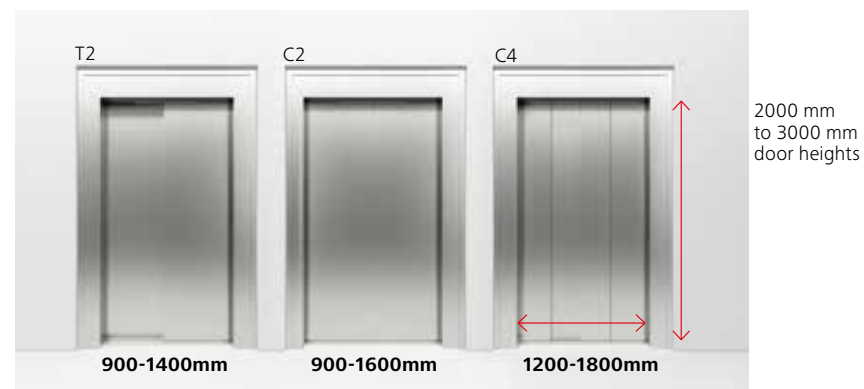

Architectural flexibility

Less space, more capacity

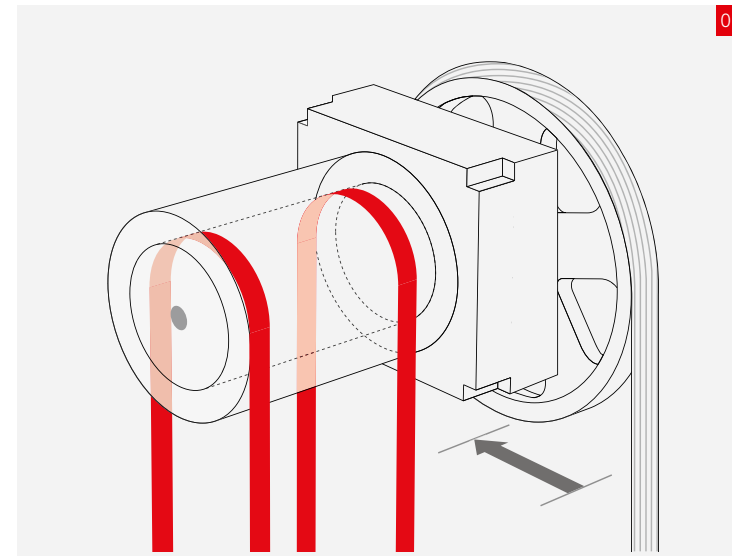

01 Smaller motor and traction sheave

Schindler's Suspension Traction Media (STM) system guarantees a quieter, smoother ride and does not require any oil or lubricant. STM also saves shaft space because of the smaller motor and traction sheave – 70% smaller than traditional systems. For passengers that means a better ride, while building owners will appreciate the increased reliability and efficiency.

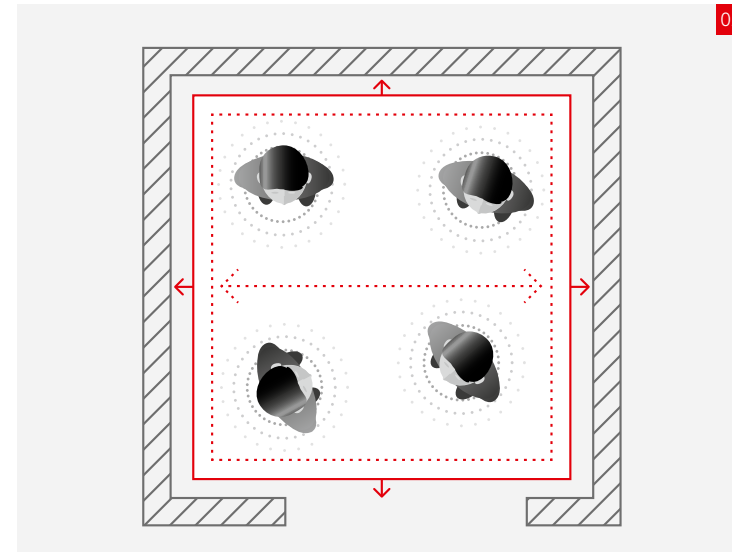

02 More usable building space

Less space for components, more usable building space and more room for passengers. Schindler 6000's innovative platform ensures that a standard-sized shaft can carry a wider car with bigger load capacity.

Future ready

Schindler elevators designed for next-generation technologies

Benefit from our tools, solutions and latest innovations to support you through the entire product life cycle of your elevator. Our elevators are designed to use state-of-the-art technologies from planning to operation.



Plan & Design online

With just a few clicks, you can plan just the right elevator for your building. Our online **Plan & Design tool** provides you with recommendations, comprehensive product specifications and detailed layout drawings. All of these are compatible with **Building Information Modeling** standards, and with our **Project Cloud** you can share your projects with us.



Innovation in installation

Schindler's new **INEX (Installation Excellence)** system not only reduces construction preparation and resources for our customers, it also improves safety and efficiency on site.



Smart operation – switching to digital

All our new elevators are fully enabled for **Schindler Ahead** – our IoT (Internet of Things) portfolio of services. With Schindler Ahead, we make sure that our customers can step confidently into the digital era.

– Maximise uptime with Ahead Remote Monitoring

With digital connectivity, issues can be detected and addressed well before service is affected. This helps facilities take timely action to minimise or even avoid downtime. Schindler Ahead maximises uptime thanks to instant, accurate insights.

– Real-time insights with Ahead ActionBoard

Schindler Ahead ActionBoard provides operational, performance and commercial information in real time, giving customers clear, instant oversight of their entire elevator and escalator portfolio.

User experience on a next level

Schindler Ahead MediaScreen makes paper a communication tool of the past. This in-car media solution provides relevant information to the passengers in real-time. Share building updates, news, weather, ensuring that passengers always stay informed.

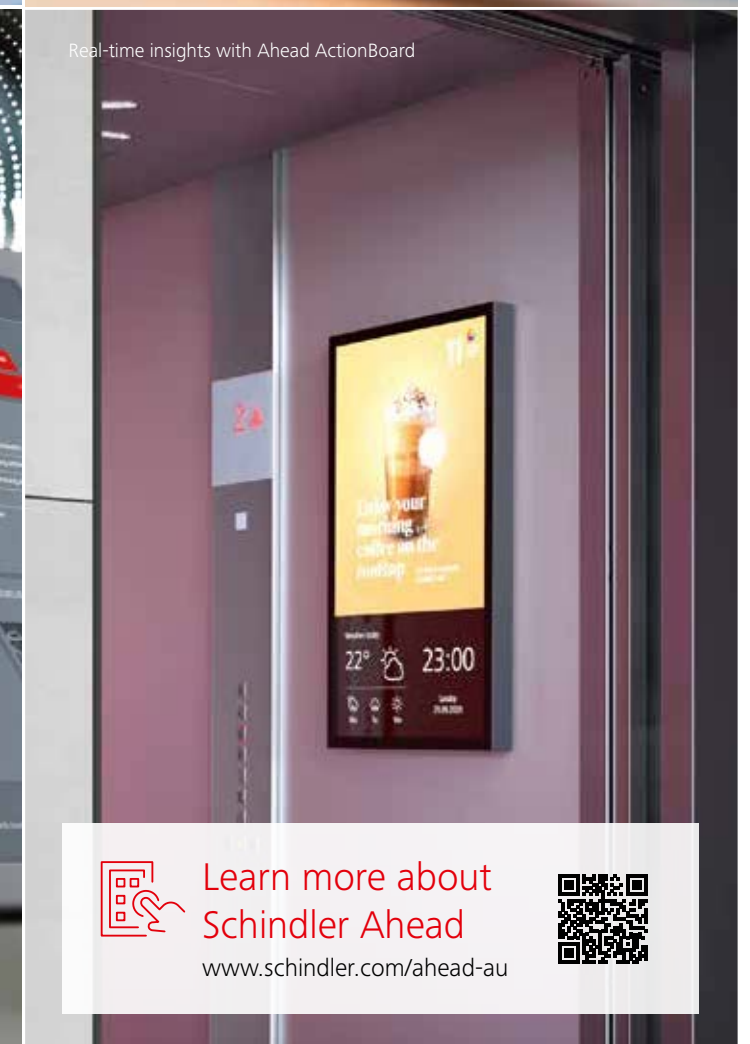

Learn more about
Schindler Ahead

www.schindler.com/ahead-au



Navona
Functional and durable



Times Square
Modern and versatile



Park Avenue
Sophisticated and elegant



Custom design
Design your own interior



Freedom of design

Create the look and feel you like

Multiple design options

Ready-made interior design lines

Choose an elevator design that is perfectly matched for your building interior. Select from four décor lines and combine your choice with our range of operating panels, handrails, lighting, mirrors and other accessories.

or full custom designs, the Schindler 6000 bare car option allows up to 50% of the car's rated capacity for you to add the materials and finishings of your choice.

Navona
Functional and durable

Simplicity and comfort in your lift with this robust design line. Fresh colours, durable accessories, and the option of twelve different floors make Navona an excellent choice for residential applications. Stainless steel options are available for rear and side walls.

Times Square
Modern and versatile

Achieve a contemporary look, choose from warm or cool colours or combine to enhance contrast for more depth. Times Square adds distinctive features to any public, commercial or residential building.

Park Avenue
Sophisticated and elegant

Offering a touch of class, the Park Avenue offers wooden and textured laminates for a rich, contemporary mode. For a luxury feel, a range of stainless steel and decorative glass is available in multiple different finishes. Complete your lift design with matched lighting for an enhanced look.

Sunset Boulevard
Inspiring and bold

Aim high for passenger excitement in upmarket locations like hotels, clubs, and restaurants. The combination of premium-quality materials, captivating patterns and splashy color gradients make this car a unique experience. Make your elevator your stage.



Design your elevator in minutes

Explore the wide range of combinations available with our easy-to-use online configuration tool:
www.schindler.com/plan-au



Note: Specifications, options and colours are subject to change. All cars and options illustrated in this brochure are representative only. The samples shown may vary from the original in colour and material.

Navona











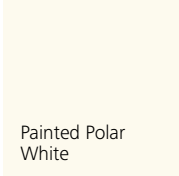



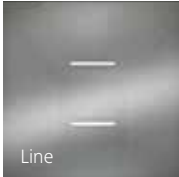

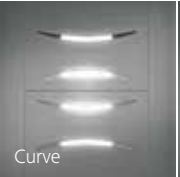
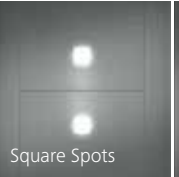
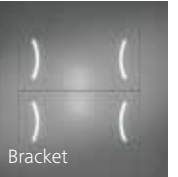

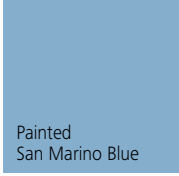

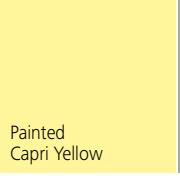
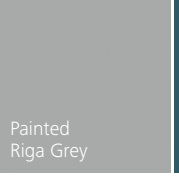





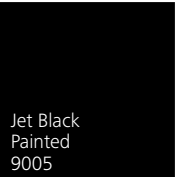

Functional and durable

Fresh colours, durable accessories, and the option of twelve different floors make Navona an excellent choice for residential applications including a stainless steel option for rear and side walls.

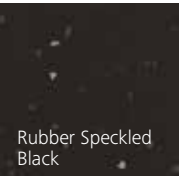

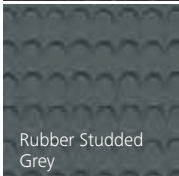
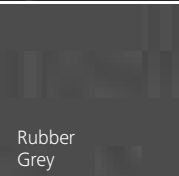
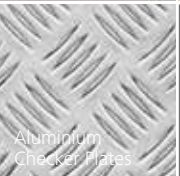
Navona

Lighting: Line
Ceiling: Stainless Steel Hairline
Walls: Painted Riga Grey
Car operating panel: Linea 100
Skirting: Flush Aluminium Anodised
Floor: Rubber Speckled Black

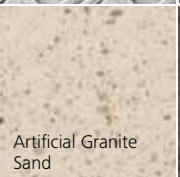
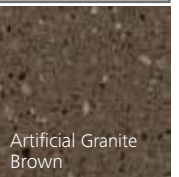
 Ceiling	 Painted Polar White	 White Aluminium 9006	 Stainless Steel Hairline		
 Lighting	 Line	 Round Spots	 Curve	 Square Spots	 Bracket
 Walls	 Painted San Marino Blue	 Painted Genoa Green	 Painted Capri Yellow	 Painted Riga Grey	 Painted Oxford Green
		 Stainless Steel Hairline			
 Car door & Car fronts	 Stainless Steel Hairline	 Stainless Steel Linen			
 Skirting	 Protruding	 Flush			
	 White Aluminium 9006	 Stainless Steel Hairline	 Jet Black Painted 9005		
 Floor	 Rubber Speckled Dark Grey	 Rubber Speckled Black	 Rubber Speckled Light Grey	 Rubber Speckled Sand	
	 Rubber Studded Grey	 Rubber Grey	 Aluminium Checker Plates	 Bare	
	 Artificial Granite Black	 Artificial Granite Grey	 Artificial Granite Sand	 Artificial Granite Brown	

Times Square











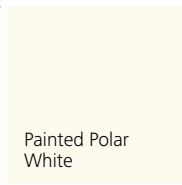



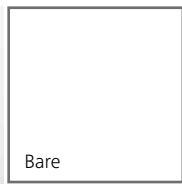

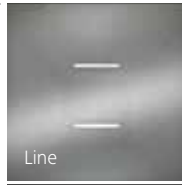

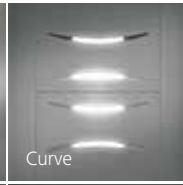
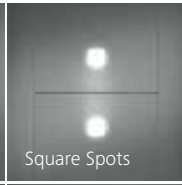
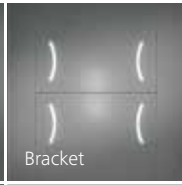
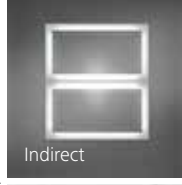
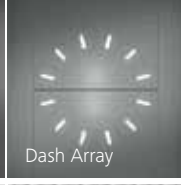
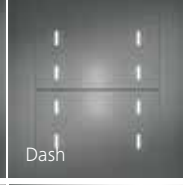
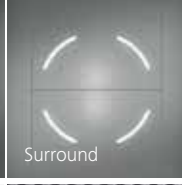

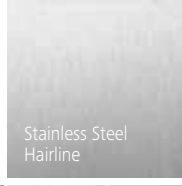
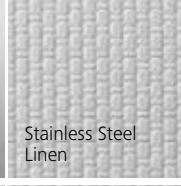

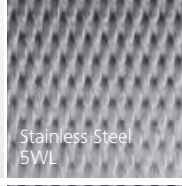
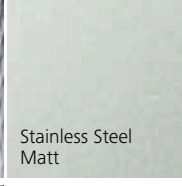
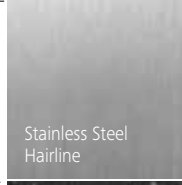
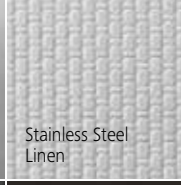

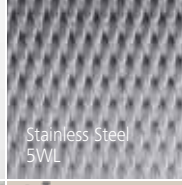





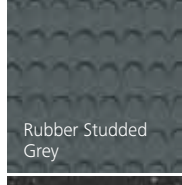
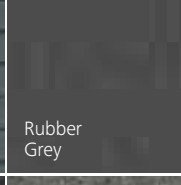

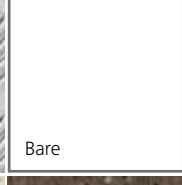

Modern and versatile

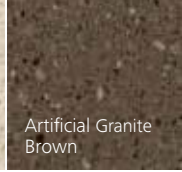
Times Square adds distinctive features to any public, commercial or residential building.

Choose from warm and cool colours to create a fresh look or combine the options to enhance contrast for more depth. Use a bare car option to create your own style and taste to perfectly match your building.



Times Square
Lighting: Square Spots
Ceiling: Stainless Steel Hairline
Walls: Stainless Steel Hairline
Car operating panel: Linea 100
Skirting: Flush Aluminium Anodised
Floor: Artificial Granite Grey

 Ceiling	 Painted Polar White	 White Aluminium 9006	 Stainless Steel Hairline	 Stainless Steel Polished Mirror	 Bare
 Lighting	 Line	 Round Spots	 Curve	 Square Spots	 Bracket
	 Indirect	 Dash Array	 Dash	 Surround	 Bare
 Walls	 Stainless Steel Hairline	 Stainless Steel Linen	 Stainless Steel Polished Mirror	 Stainless Steel SWL	 Stainless Steel Matt
	 Stainless Steel Hairline	 Stainless Steel Linen	 Stainless Steel Polished Mirror	 Stainless Steel SWL	
 Car door & Car fronts	 Rubber Speckled Dark Grey	 Rubber Speckled Black	 Rubber Speckled Light Grey	 Rubber Speckled Sand	
	 Rubber Speckled Dark Grey	 Rubber Speckled Black	 Rubber Speckled Light Grey	 Rubber Speckled Sand	
 Floor	 Rubber Studded Grey	 Rubber Grey	 Aluminium Checker Plates	 Bare	
	 Rubber Studded Grey	 Rubber Grey	 Aluminium Checker Plates	 Bare	
	 Artificial Granite Black	 Artificial Granite Grey	 Artificial Granite Sand	 Artificial Granite Brown	













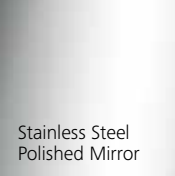

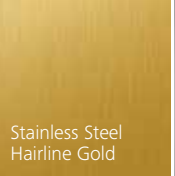
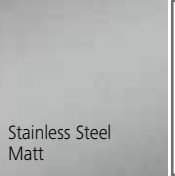
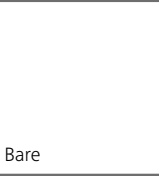

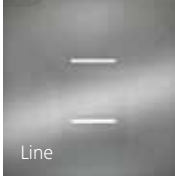

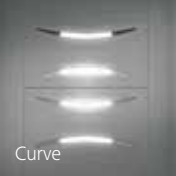
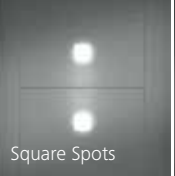
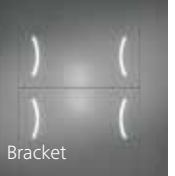
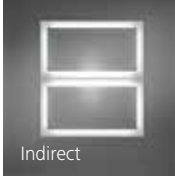

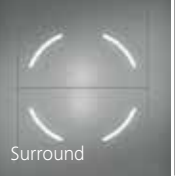

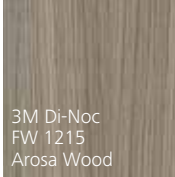

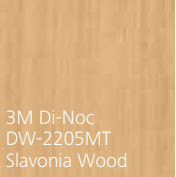
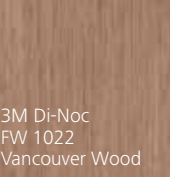



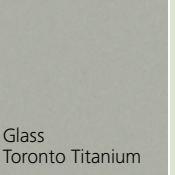
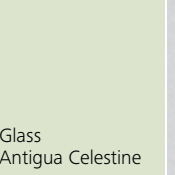
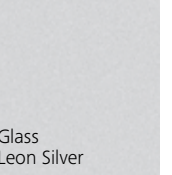









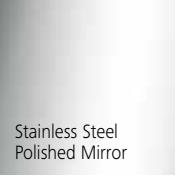

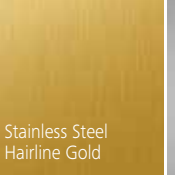





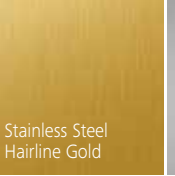

Park Avenue

Sophisticated and elegant

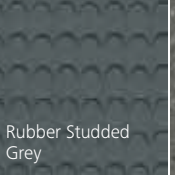
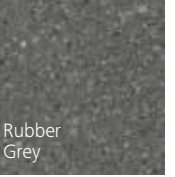
Choose from laminates or stainless steel walls for a rich, contemporary mood. Alternatively create a luxury feel with stainless steel available in five different finishes or decorative 3M Di-Noc finish. Matched lighting available to complete your look.

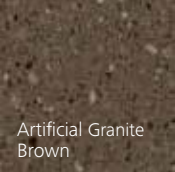
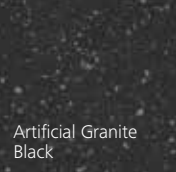

Park Avenue
Lighting: Line
Ceiling: Stainless Steel Hairline Dark
Walls: Stainless Steel Hairline Dark
Car operating panel: Linea 100
Skirting: Flush Aluminium Anodised
Floor: Artificial Granite Black

 Ceiling	 Stainless Steel Hairline	 Stainless Steel Polished Mirror	 Stainless Steel Hairline Dark	 Stainless Steel Hairline Gold	 Stainless Steel Matt	 Bare	
 Lighting	 Line	 Round Spots	 Curve	 Square Spots	 Bracket		
	 Indirect	 Dash Array	 Dash	 Surround	 Bare		
 Walls	 3M Di-Noc FW 1215 Arosa Wood	 3M Di-Noc DW 1992MT Chicago Wood	 3M Di-Noc DW-2205MT Slavonia Wood	 3M Di-Noc FW 1022 Vancouver Wood			
	 Glass Petersburg Amber	 Glass Helsinki Grey	 Glass Jodhpur Blue	 Glass Kashmir Blue	 Glass Toronto Titanium	 Glass Antigua Celestine	 Glass Leon Silver
	 Glass Stockholm Grey	 Glass Shanghai Red	 Glass Clear Glass (rear wall only)	 Bare	 Custom Back Painted Glass to NCS Colour Code	 Custom Back Painted Glass to RAL Colour Code	
 Car door & Car fronts	 Stainless Steel Hairline	 Stainless Steel Linen	 Stainless Steel Polished Mirror	 Stainless Steel 5WL	 Stainless Steel Hairline Dark	 Stainless Steel Hairline Gold	 Stainless Steel Matt
	 Stainless Steel Hairline	 Stainless Steel Linen	 Stainless Steel Polished Mirror	 Stainless Steel 5WL	 Stainless Steel Hairline Dark	 Stainless Steel Hairline Gold	 Stainless Steel Matt
 Floor	 Rubber Speckled Black	 Rubber Speckled Light Grey	 Rubber Speckled Sand	 Rubber Speckled Dark Grey	 Rubber Studded Grey	 Rubber Grey	
	 Artificial Granite Sand	 Artificial Granite Brown	 Artificial Granite Black	 Artificial Granite Grey	 Aluminium Checker Plates	 Bare	

Sunset Boulevard













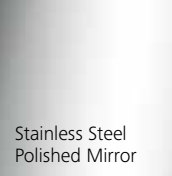

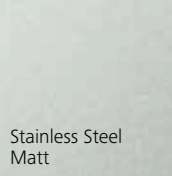
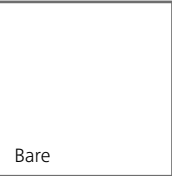

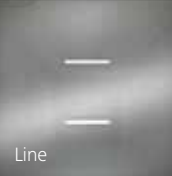

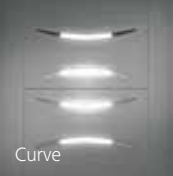

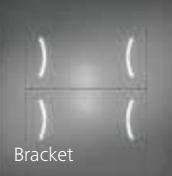















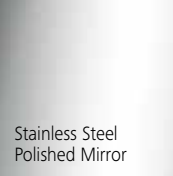





Inspiring and bold

Aim high for passenger excitement in upmarket locations like hotels, clubs and restaurants. The combination of premium-quality materials, captivating patterns and splashy colour gradients make this car a unique experience. Make your elevator your stage.

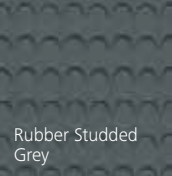

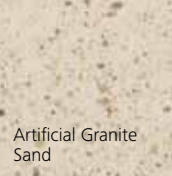
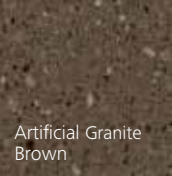
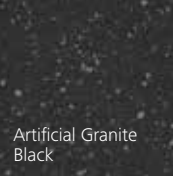
Sunset Boulevard

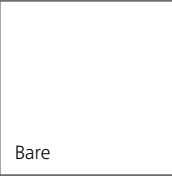
Lighting: Indirect
Ceiling: Stainless Steel Hairline
Walls: Clear Glass
Car operating panel: Linea 300
Skirting: Flushed Stainless Steel Hairline
Floor: Artificial Granite Black

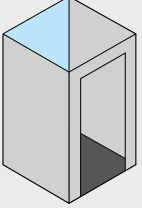
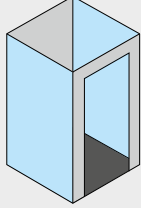
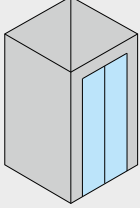
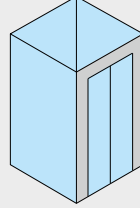
 Ceiling	 Stainless Steel Hairline	 Stainless Steel Polished Mirror	 Stainless Steel Dark	 Stainless Steel Gold	 Stainless Steel Matt	 Bare	
 Lighting	 Line	 Round Spots	 Curve	 Square Spots	 Bracket		
	 Indirect	 Dash	 Dash Array	 Surround	 Bare		
 Walls	Includes Navona, Times Square and Park Avenue colours and materials, plus:						
	 Digital Print on glass Detroit Grey	 Digital Print on glass New York Sunset	 Digital Print on glass Antalya Blue	 Digital Print on glass Moscow Red	 Digital Print on glass Luxor Gold	 Digital Print on glass Marrakesh Mocca	
 Car door & Car fronts	 Stainless Steel Hairline	 Stainless Steel Linen	 Stainless Steel Polished Mirror	 Stainless Steel SWL	 Stainless Steel Hairline Dark	 Stainless Steel Hairline Gold	 Stainless Steel Lugano Matt (304)
 Floor	 Rubber Speckled Black	 Rubber Speckled Light Grey	 Rubber Speckled Sand	 Rubber Speckled Dark Grey	 Rubber Studded Grey	 Rubber Grey	
	 Artificial Granite Sand	 Artificial Granite Brown	 Artificial Granite Black	 Artificial Granite Grey	 Aluminium Checker Plates	 Bare	
 Glass car	   						
	Glass rear wall	Glass side walls	Glass door	Glass rear & side walls, glass door			

Car operating panels and landing fixtures

Linea 100

Our operating panels and fixtures are ergonomically designed to make the passenger experience intuitive, smooth and simple. The Linea 100 incorporates low energy multiprocessor controls and operating panels fashioned in stylish, tempered safety glass.

- 01 Linea 100 half-height car operating panel
- 02 Landing indicator panel
- 03 Linea 100 landing operating panels
- 04 Passenger service functions

Sleek design. Stylish and functional stainless steel



Disability compliant dual illuminating button with braille



01

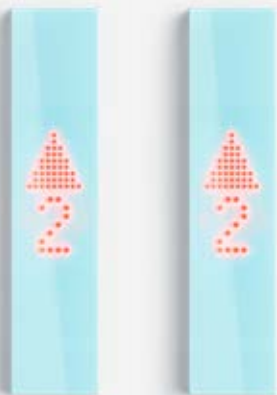

02



03



04

Bumper rails

Preserving your car interior

Designed to protect your elevator car walls and prolong their sleek looks, Schindler's damage bumper rails are available in a variety of heights, and in stainless steel or PVC.

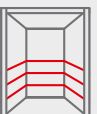

Choose from different heights depending on your requirements. Available in stainless steel or PVC.

- 01 PVC Black
- 02 Stainless Steel Hairline

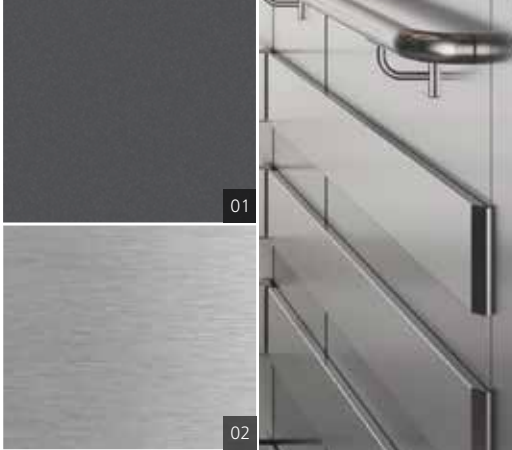

Times Square
Stainless Steel Hairline walls
Stainless Steel Hairline bumper rails





Integrated white glass display with large, easily readable red LED dot matrix

Emergency light

Sleek design. Stylish and functional Stainless Steel

Emergency call button



TFT display for clear indication

Black glass display mounted with Stainless Steel Hairline

Robust buttons with Consistent responsiveness

Stainless Steel Hairline Dark design with black glass display

Fixtures

Linea 300

An upmarket user interface to enhance your elevator's looks, with an intuitive, efficient design. The display is in black glass, with buttons positioned on elegant black stainless steel, or white glass display on typical stainless steel colour finishing.

03

05

04

06

- 01 300 Full height car operating panel
- 02 300 Full height car operating panel
- 03 300 Landing operating panels
- 04 Landing indicating panels
- 05 Disability compliant dual illuminating button with braille
- 06 Passenger service functions

01

7" Touch Panel Display Screen
with proximity sensor activation

RFID Card Reader
supports all common cards

Slim Line Glass Fronted Pedestal

Fixtures

The PORT Terminal

The new PORT hall call destination terminals deliver brainpower to your building. A range of PORT Terminal is available, with numerous options to optimise traffic flows. Now an established destination control system-worldwide, PORT terminals offer elegant design, stylish ergonomics and a contemporary look.



- 01 PORT 1 pedestal black and white
- 02 PORT 1 wide wall-mounted black
- 03 PORT 1 wide pedestal white
- 04 PORT destination indicator white
- 05 PORT destination indicator black
- 06 PORT destination indicator grey

- 07 PORT 1 pedestal black
- 08 PORT 1.2 with disabled wall-mounted white
- 09 PORT 4 flush wall-mounted black
- 10 PORT 4 surfaced wall-mounted grey

Card reader window may vary

Mirrors

Ensuring optimal appearance

Mirrors enhance the sense of space, depth and comfort in elevators. Choose from a half-height or full-height safety-glass mirror on the rear wall of the car.

Rear wall



Full height
centred



Full height
Left and Right panel



Half height
full width

Park Avenue
3M Di-Noc Vancouver Wood
walls Full-height centred mirror



Landing doors

For a stylish entrance

How your elevator design complements your building interior can enhance your tenants' response to the overall décor concept. We offer a range of colours to fulfill your building's design potential.

Landing arrangements

Simplex

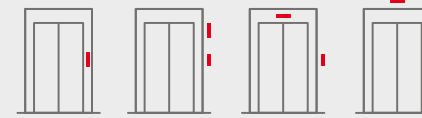

2 or more

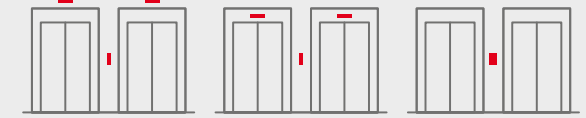

Choose your optimal landing arrangements for simplex and group installations, surface or wall mounting.



Landing door colour options

- 01 Painted Light Grey Hammer
- 02 Painted Vienna Beige Hammer
- 03 Painted Bordeaux Red Hammer
- 04 Painted Havanna Gold Hammer
- 05 Painted White Aluminium Textured
- 06 Stainless Steel Polished Mirror
- 07 Stainless Steel Hairline

Note: All landing doors are fire rated as per the NCC/BCA requirements

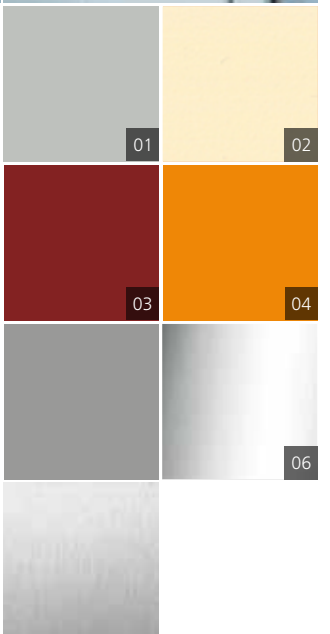

Handrails

A choice of shapes and finishes

Schindler stainless steel handrails are designed to blend with car interiors, shapes and textures, and can be mounted to the side and rear walls.

Available in straight ends.



Straight Stainless Steel Polished



Straight Stainless Steel Hairline

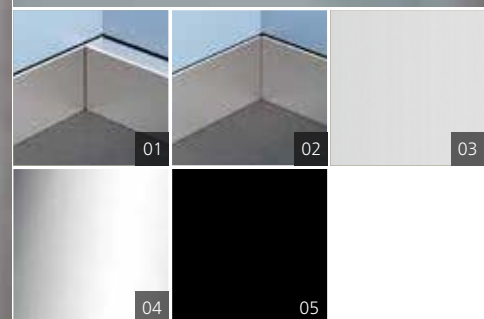
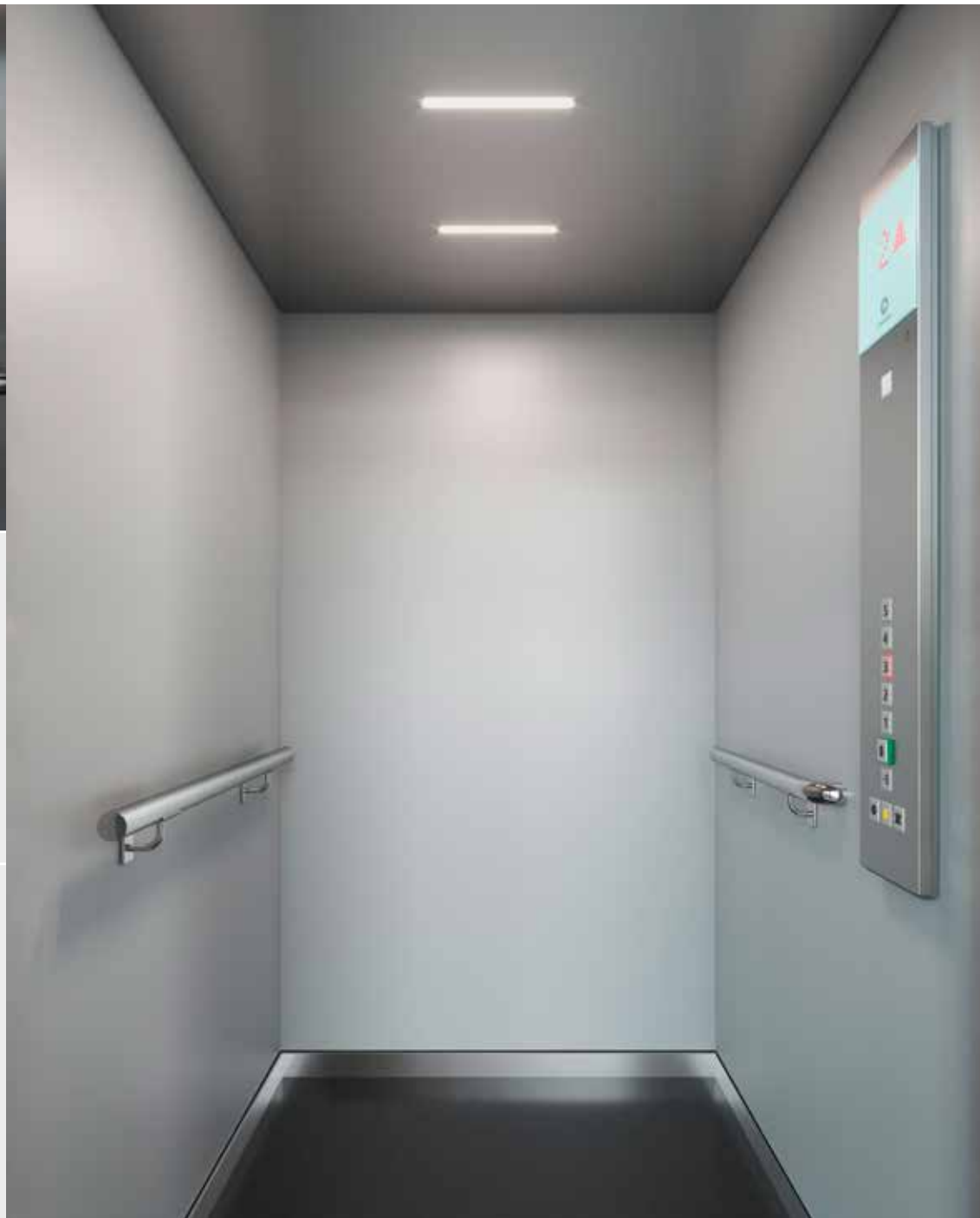

- Schindler 6000**
- 01 Protruding (side walls only)
 - 02 Flush
 - 03 White Aluminum painted
 - 04 Stainless Steel
 - 05 Jet Black Painted



Customise your handrails

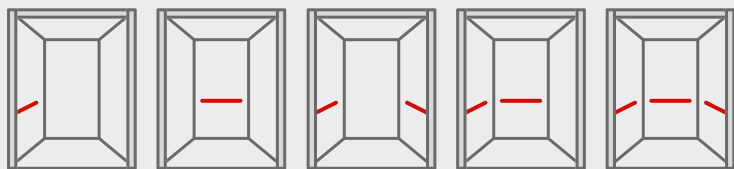

The handrails can be mounted in different combinations of side and rear walls, either only one handrail piece on the rear or side walls, two handrail pieces on the side walls or handrails on three walls.

Handrails can be chosen with two different types of finishes with straight ends.



Shapes and finishes:

Straight ends

- 01 Stainless Steel Polished Mirror
- 02 Stainless Steel Hairline

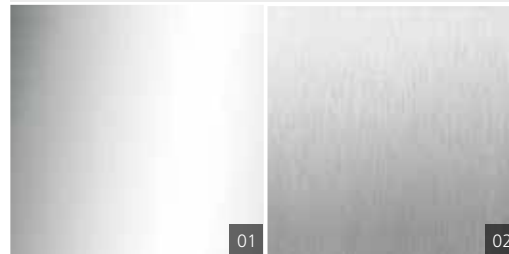

Skirting

Protect your walls

Our protruding, flush and recessed skirting range provides protection for the lift car interiors. Our practical range of skirtings seamlessly blend with our range of interiors.

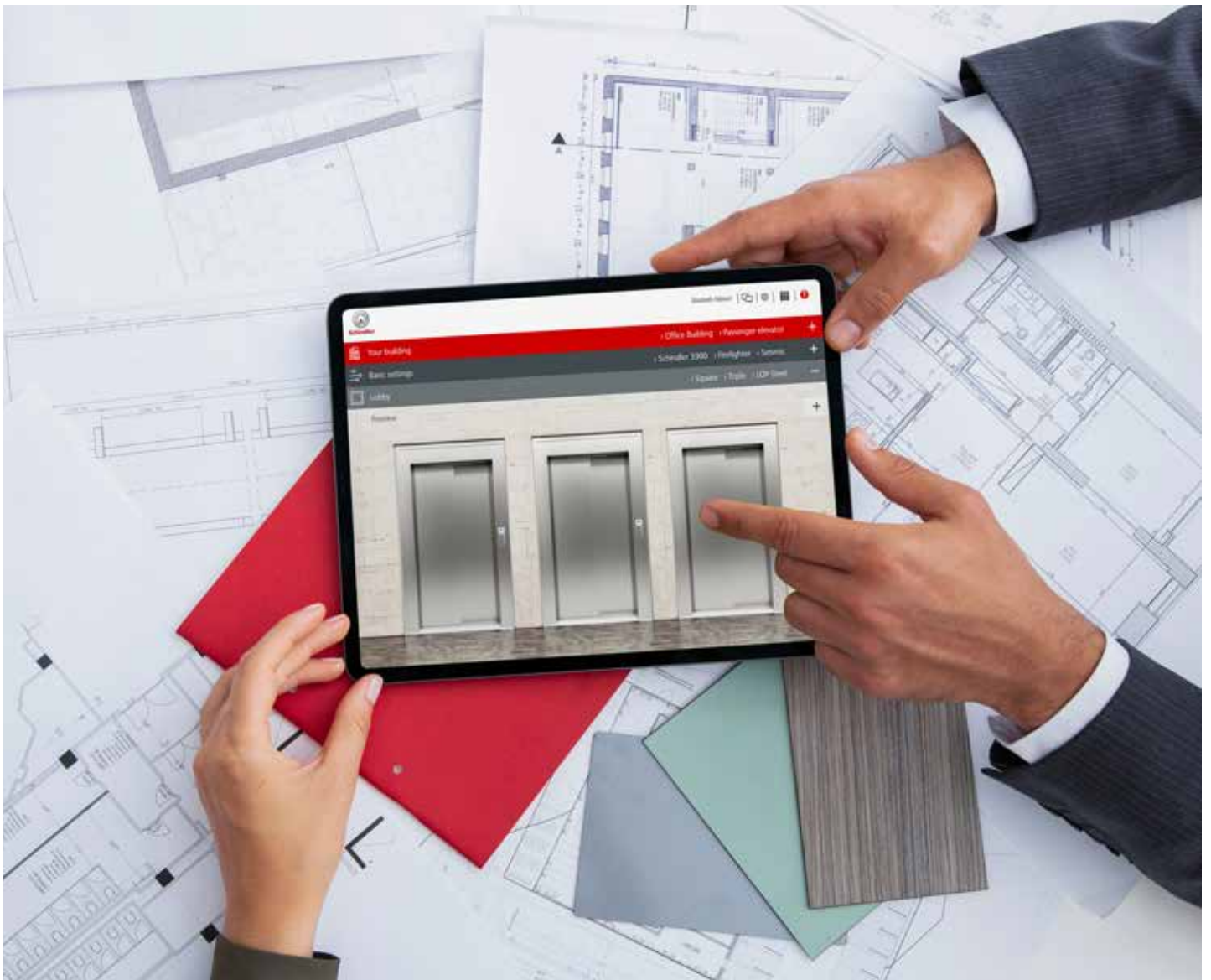

Schindler Plan & Design tool

Design your elevator layout in minutes

Our easy-to-use online planning tool makes it simple to find the matching vertical transportation setup for your building. The Schindler Plan & Design tool helps you to prepare specifications in the early stages of your building's project life cycle.

With just a few clicks, we provide you with recommendations, a comprehensive product specification, and detailed layout drawings. Simply download the data straight into your project design in DWG or PDF formats.

The solution can be integrated with Building Information Modeling standards, and our Project Cloud makes it easy for you to share your projects with us.

Schindler Lifts Australia Pty. Ltd.
T: 1300 000 000 | E: schindlersales@au.schindler.com | W: www.schindler.com

This publication is for general informational purposes only and we reserve the right at any time to alter the services, product design and specifications. No statement contained in this publication shall be construed as a warranty or condition, expressed or implied, as to any service or product, its specifications, its fitness for any particular purpose, merchantability, quality or shall be interpreted as a term or condition of any service or purchase agreement for the products or services contained in this publication. Minor differences between printed and actual colours may exist.



www.schindler.com/plan-au

We Elevate



Schindler